

GENERAL INFORMATION / INFORMAȚII GENERALE / INFORMAZIONI GENERALI

Code	Finishing	LED type	Power	Input voltage	Output current/voltage driver	Driver	LED flux	System flux	CCT	CRI	Optics	Weight
FTR420WW MWH	Mat white	SMD 2016 EPISTAR	40W	220-240V AC	950 mA / 21-42V DC	Included	4690 lm	2495 lm	3000K	83	110°	1,70 kg

Description / Descriere / Descrizione

EN - Recessed round shape light fitting, equipped with SMD LEDs, warm white color temperature.

RO - Corp încastrat cu formă rotundă, echipat cu LED-uri SMD, temperatură de culoare alb cald.

IT - Apparecchio circolare da incasso, a LED SMD, temperatura di colore bianco caldo.

Housing / Corp / Corpo

EN - die-cast aluminum housing, electrostatically painted in mat white.

RO - Corp din aluminiu turnat sub presiune, vopsit în câmp electrostatic, culoare alb mat.

IT - Corpo in pressofusione di alluminio, verniciato a polveri bianco opaco.

Optics / Sistem optic / Ottica

EN - Diffuser of polystyrene with screen printed grid, polyethylene reflector.

RO - Dispersor din polistiren cu rețea de difuzie serigrafată și reflector din polietilenă.

IT - Diffusore in polistirene, con retino diffusore serigrafato e riflettore in polietilene.

Electric gear / Aparataj de alimentare / Alimentazione

EN - Constant current LED driver delivered with the panel. Connector "plug-in" type between LED panel and driver. Connector 2P, 2,5 mm² max. at the driver entry.

RO - Alimentator în curent constant livrat împreună cu panoul. Conector tip "plug-in" între panou și alimentator. Conector 2P, max. 2,5 mm² la intrarea în alimentator.

IT - Alimentatore in corrente costante fornito con il pannello. Connettore tipo "plug-in" tra pannello e l'alimentatore. Connettore 2P, max. 2,5 mm² all'entrata dell'alimentatore.

Important / Important / Importante

EN - Whichever the place and the type of mounting, the free space over the LED panel downlight must ensure its cooling and free flow of the air.

RO - Indiferent de locul și tipul de montaj, spațiul aflat deasupra fiecărui panou cu LED-uri trebuie să asigure răcirea acestuia și libera circulație a aerului.

IT - Qualunque posizione di installazione deve prevedere uno spazio sopra l'apparecchio per assicurare una corretta ventilazione dell'apparecchio.

Range of applications / Aplicații / Campi di applicazione

EN - General interior lighting.

RO - Iluminatul general de interior.

IT - Illuminazione generale d'interni.

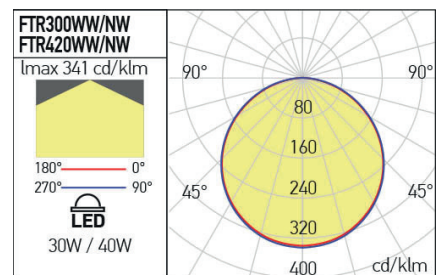
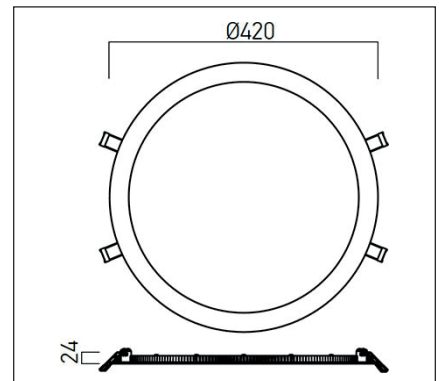

ErP and ecodesign data Date ErP și ecodesign Dati ErP ed ecodesign

Lighting technology used:	LED
Directional or non-directional:	NDLS
Mains or non-mains:	NMLS
CLS:	No
Color tunable light source:	No
Anti-glare shield:	No
Dimmable:	No
Energy consumption (kWh/1000h):	35
Energy efficiency class:	E
Useful luminous flux (Øuse):	4240 lm
Correlated color temperature:	3000K
On-mode power (Pon):	34,47W
Standby power (Psb):	≤0,50
Networked standby power (Pnet):	-
Outer dimensions (HxWxL, HxØ):	19x300 mm
CRI:	83
Chromaticity coordinates (x and y):	x=0.4353, y=0.3970
Peak luminous intensity (cd):	-
Beam angle in degrees:	110°
R9 color rendering index:	1
Survival factor:	100%
Lumen maintenance factor:	96%
Displacement factor (cosφ1):	-
McAdam ellipses:	6
Flicker metric (Pst LM):	≤1
Stroboscopic effect metric (SVM):	≤0,4
Ponmax:	37,53W

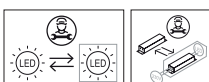

Standards:

EN 60598-1:2015 + A1:2018, EN 60598-2-2:2012, EN 62493:2015, EN 62471:2008, EN 62031:2008 + A1:2013 + A2:2015, EN 60529:1992 + A2:2013, EN 55015:2019 + A11:2020 + A1:2015, EN 61000-3-2:2019, EN 61000-3-3:2013 + A1:2019, EN 61547:2009.